

2MP WDR Vandal-resistant Fixed Dome Network Camera

IPC322SR3-DVSPF28 (40)-B



Key Features

Optics

- Day/night functionality
- Smart IR, up to 30 m (98 ft) IR distance
- Up to 120 dB WDR (Wide Dynamic Range)
- 3D DNR (Digital Noise Reduction)

Compression

- H.265, H.264, MJPEG
- Embedded smart algorithm
- Triple streams
- ROI (Region of Interest)
- Customized OSD

Network

- ONVIF Conformance

Structure

- Wide temperature range: -35°C to 60°C (-31°F to 140°F)
- Wide input voltage range of $\pm 25\%$
- IK10 vandal resistant

- IP66

Specifications

	IPC322SR3-DVSPF28-B	IPC322SR3-DVSPF40-B
Camera		
Sensor	1/2.9", 2 megapixel, progressive scan CMOS	
Shutter	Auto/Manual, 1/6~1/100000 s	
Lens	2.8 mm@F2.2 Angle of view(H): 105.2°	4.0 mm@F2.2 Angle of view(H): 79.7°
Day/Night	IR-cut filter with auto switch (ICR)	
Min. Illumination	Colour: 0.2 Lux (F2.2, AGC ON) 0 Lux with IR	
S/N	>52 dB	
WDR	Optical WDR(up to 120dB)	
Noise Reduction	2D/3D	
Video		
Max. Resolution	1920 × 1080	
Video Compression	H.265, H.264, MJPEG	
Frame Rate	1080P (1920*1080): MAX. 30 fps; 720P (1280*720): MAX. 30 fps	
Video Streaming	Triple	
9:16 Corridor Mode	Supported	
ROI	Supported	
OSD	Up to 8 OSDs	
Privacy Mask	Up to 8 areas	
Smart		
Behavior Detection	Intrusion, crossing line, motion detection	
Intelligent Identification	Face detection	
Statistical Analysis	People counting	
Storage		
Edge Storage	Micro SD, up to 128 GB	
Network		
Protocols	L2TP, IPv4, IGMP, ICMP, ARP, TCP, UDP, DHCP, PPPoE, RTP, RTSP, RTCP, DNS, DDNS, NTP, FTP, UPnP, HTTP, HTTPS, SMTP, SIP, 802.1x	
Compatible Integration	ONVIF, API	
Interface		
Network	10M/100M Base-TX Ethernet	
General		
Power	12 V DC, or PoE (IEEE802.3 af)	
	Power consumption: Max 5.5W	
Dimensions (Ø x H)	Ø108.5 x 81 mm (Ø4.28" x 3.2")	
Weight	0.45 kg (0.99 lb)	

Working Environment	-35°C ~ +60°C (-31°F ~ 140°F), Humidity ≤ 95% RH(non-condensing)
Vandal Resistant	IK10
Ingress Protection	IP66

Dimensions

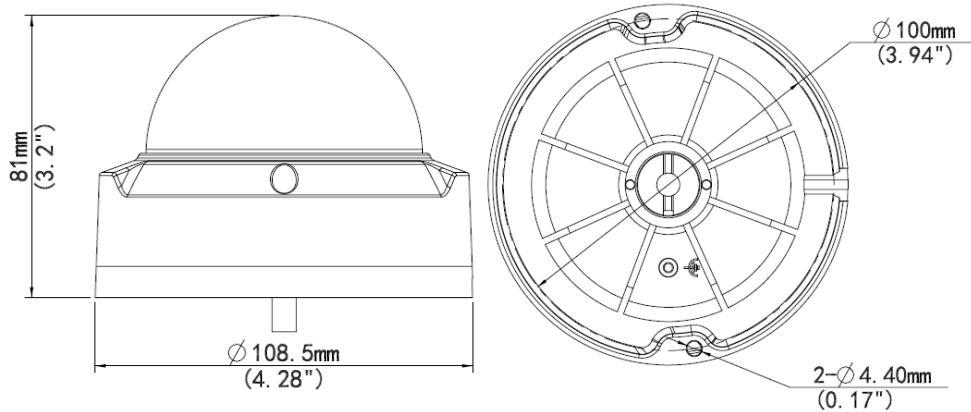

Accessories

Installation mode	Accessories	Description
Ceiling mount	Mounting pedestal is included in the product package	TR-JB03-B-IN junction box and TR-A01-IN waterproof joint for the junction is optional
Wall mount	TR-WM03-A	For indoor wall installation, excluding junction box
	TR-JB07/WM03-A-IN	For outdoor wall installation, including junction box TR-A01-IN waterproof joint for the junction is optional
Pole mount	TR-WM03-A +TR-UP06-IN	For indoor wall installation, excluding junction box
	TR-JB07/WM03-A-IN+TR-UP06-IN	For outdoor wall installation, including junction box
Pendant mount	TR-UF45-D-IN+TR-CE45-IN	For indoor pendent installation
Tilted mounting	TR-UM06-B-IN	\

Zhejiang Uniview Technologies Co., Ltd.

South Tower, Building 10, Wanlun Science Park, 88 Jiangling Road, Hangzhou, P.R.China 310051

Email: overseasbusiness@uniview.com; globalsupport@uniview.com

<http://www.uniview.com>

©2016 Zhejiang Uniview Technologies Co., Ltd. All rights reserved.

*Product specifications and availability are subject to change without notice.